

**LOCKS**

**GLASS DOOR LOCK FOR OVERLAY DOORS**

An elegant lock for overlay doors of glass from 4mm to 6mm in thickness. Requires a 26mm hole in door, a 5mm hole in case. Hole locations vary depending upon overlay. Rubber spacers provided to compensate for glass thickness. Keyed alike or keyed different. Special order 2-3 day delivery. Matt nickel plate. **GLASSHOLELOC**

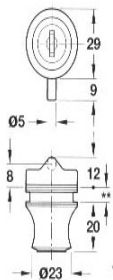
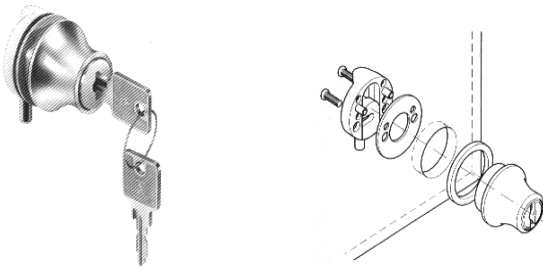

**GLASS DOOR LOCK FOR SLIDING DOORS**

This cylinder lock with plug-in cylinder is for glass panels from 6-8mm. Key is removable only when locked. Provided with 2 keys, 2 rubber washers, and mounting screws. Keyed alike or keyed different. Special order 2-3 day delivery. Nickel-plated steel. **SLIDEHOLELOC**

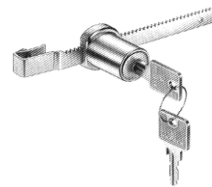
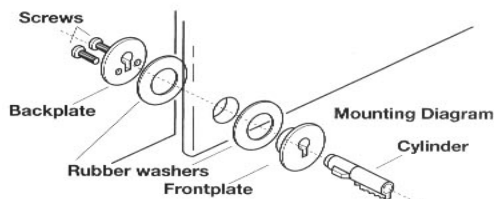
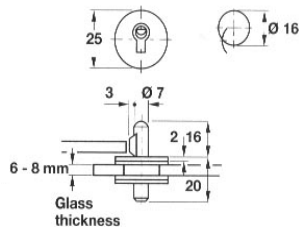

**RATCHET LOCK, P965** for 1/4" material that overlaps 3/4" to 3-3/8", Keyed alike, nickel plate only.

**FLAP LOCK** screw on type, made of diecast zinc. Key can be removed in locked or unlocked position. Order #4 screws separately. Stocked keyed alike. Brass plate **FLAPLOCKBRKA**

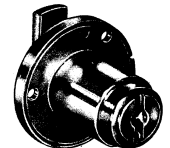

**CS989AL** The secret gate latch is made from cast aluminum in a natural finish. Case is 2" x 2-3/8" and is interchangeable left or right mounting.

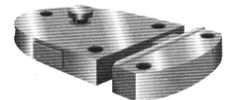

**PLUNGER LOCKS** are solid brass with plating as specified. May be used with doors up to 1" thick. Mounting flange is 7/8" x 2" with screw holes 1-1/2" on center. Screws provided. Sockets for plunger are not provided.

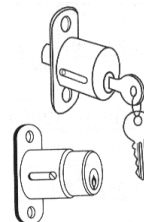

Barrel: 7/8" O.D. Plunger travel: 15/32" Plunger receptacle: 1/2" O.D. x 7/16" overall. Available: Nickel finish keyed alike **CS984NPKA**

**PLUNGER LOCKS** to match in key our most popular cam and dead bolt locks, steel, with appropriate finish.



Barrel: 7/8" O.D. Cylinder length: 1" Plunger travel: 7/16" Plunger receptacle: 1/2" O.D. x 7/16" overall. Available: Nickel finish keyed alike **C804314KA415** Brass finish keyed alike **C80433KA415**

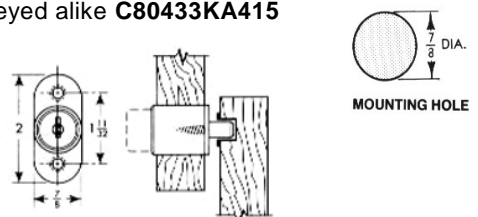

**GANG LOCK** – For locking drawers in desk pedestals and other multiple drawer applications. Requires 7/8" dia. hole for cylinder and dado for bar, measuring 7/8"x1/8" deep on inside of panel. Key removable in both locked and unlocked positions. Includes 2 keys, 3 locking studs, 3 stud slides, saddle and mounting screws.

- Polished Brass:  
**C80903KA415**
- Polished Nickel:  
**C809014KA346**  
**C809014KA390**  
**C809014KA415**  
**C809014KD**

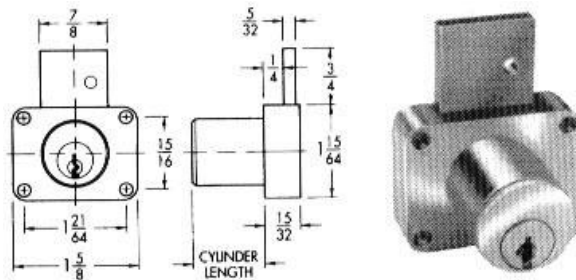
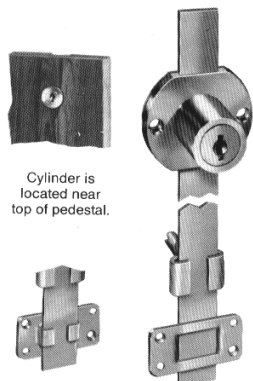

**C817926DK915d**

Nickel-plate deadbolt lock, surface mount, keyed alike. For 1-3/8" material, drill 7/8" for keyway. This is pin tumbler (high security).

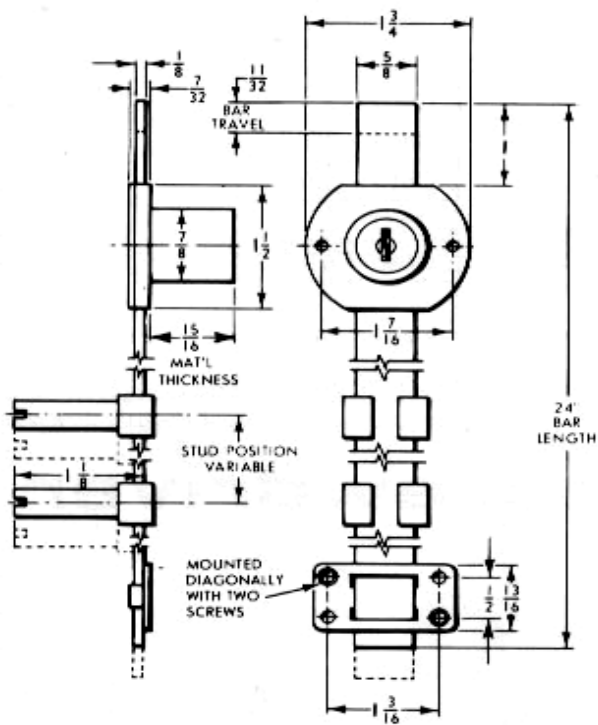

**DISC TUMBLER CYLINDER CAM LOCKS**

Application - for drawers, R.H. or L.H. doors with either lipped or flush construction. 3/4" hole for cylinder.

Operation - 90 degree cam turn, Key removable in both locked and unlocked positions.

Keying - From our stock, a choice of 6 different keys for keying alike, up to 75 different keys for keying different, keying different with master keying, and matching keys (#415) to central locking devices.

Packaging - Sold individually, packed 25 in a box, with two keys, trim washer, spur washer for wood, and two cams (1 for inset, 1 for lipped).

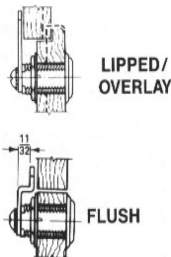

**AVAILABLE CAMS**

**CAM805X2** - 2" or 3" (depending on availability) long cam for extra deep backset of lock. Please specify length preferred



**CAM80537/8** - for use with the 8053 in an overlay application. Combined frame and door material thickness may not exceed 1-9/16", and door thickness may not exceed 7/8".



**HOOKCAM** will catch on to a screw shank - allows use of the lock in sliding applications. 1-1/2" long, from center of hole to end of cam.



**CAM DIMENSIONS**

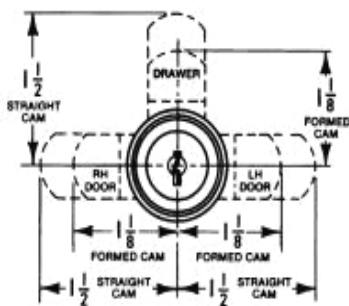

Part Color	Keying	Supplied for Mounting	Finish	Cylinder Length	Max. Mat. Thickness
C805214KA346	346	lipped and flush	nickel	5/8"	1/4"
C805314KD	keyed different	lipped and flush	nickel	1-3/16"	7/8"
C805314KA415	415	lipped and flush	nickel	1-3/16"	7/8"
C805314KA346	346	lipped and flush	nickel	1-3/16"	7/8"
C805314KA390	390	lipped and flush	nickel	1-3/16"	7/8"
C805314KA413	413	lipped and flush	nickel	1-3/16"	7/8"
C805314KA420	420	lipped and flush	nickel	1-3/16"	7/8"
C805314KA642	642	lipped and flush	nickel	1,3/16"	7/8"
C805314KDMK	Keyed different, master key *	lipped and flush	nickel	1-3/16"	7/8"
C80533KD	keyed different	lipped and flush	pol. brass	1-3/16"	7/8"
C80533KA415	415	lipped and flush	pol. brass	1 3/16"	7/8"
C80533KA390	390	lipped and flush	pol. brass	1-3/16"	7/8"
C80533KA413	413	lipped and flush	pol. brass	1-3/16"	7/8"
C8053BLKA01	001	flush	Gloss black	1-1/4"	7/8"
C805514KA415	415	lipped and flush	nickel	1-7/16"	1-1/8"
C805514KA420	420	lipped and flush	nickel	1-7/16"	1-1/8"
C805514KD	keyed different	lipped and flush	nickel	1-7/16"	1-1/8"
C80553KA346	346	lipped and flush	pol. brass	1-7/16"	1-118"
C806014KA346	346	lipped and flush	nickel	1-3/4"	1-13/32"
C806014KA390	390	lipped and flush	nickel	1-3/4"	1-13/32"
C806014KA413	413	lipped and flush	nickel	1-3/4"	1-13/32"
C806014KA415	415	lipped and flush	nickel	1-3/4"	1-13/32"
C806014KA420	420	lipped and flush	nickel	1-3/4"	1-13/32"
C806014KA642	642	lipped and flush	nickel	1-3/4"	1-13/32"
C806014KDMK	keyed different, master key*	lipped and flush	nickel	1-3/4"	1-13/32"
C80603KA346	346	lipped and flush	pol. brass	1-3/4"	1-13/32"
C80603KA390	390	lipped and flush	pol. brass	1-3/4"	1-13/32"
C80603KA413	413	lipped and flush	pol. brass	1-3/4"	1-13/32"
C80603KA415	415	lipped and flush	pol. brass	1-3/4"	1-13/32"

\*MASTERKEY sold Separately, and required

**DISC TUMBLER DOOR & DRAWER LOCKS**

**APPLICATION** - For drawers and doors. Surface mounted, requires 7/8" hole for cylinder. Operation - Key removable in locked and unlocked positions.

**KEYING** - Stocked keyed alike and different, varying with the particular lock. Any key requirement can be met through special order.

**PACKAGING** - Sold individually, packed 25 in a box, supplied with two keys and mounting screws.

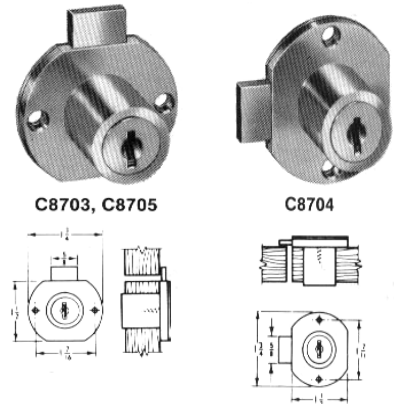

<u>Stock Number</u>	<u>Keying</u>	<u>Installation</u>	<u>Cylinder Length</u>	<u>Bolt Travel</u>	<u>Finish</u>
<b>C870314KD</b>	keyed different	drawer	15/16"	11/32"	nickel
<b>C870314KA415</b>	415	drawer	15/16"	11/32"	nickel
<b>C870314KA420</b>	420	drawer	15/16"	11/32"	nickel
<b>C87033KD</b>	keyed different	drawer	15/16"	11/32"	pol. brass
<b>C87033KA346</b>	346	drawer	15/16"	11/32"	pol. brass
<b>C87033KA415</b>	415	drawer	15/16"	11/32"	pol. brass
<b>C87033KA390</b>	390	drawer	15/16"	11/32"	pol. brass
<b>C87033KA413</b>	413	drawer	15/16"	11/32"	pol. brass
<b>C870414KA415</b>	415	door	15/16"	11/32"	nickel
<b>C87043KD</b>	key different	door	15/16"	11/32"	pol. brass
<b>C87043KA415</b>	415	door	15/16"	11/32"	pol. brass
<b>C87053KA346</b>	346	drawer	1-3/16"	11/32"	pol. Brass

**STRIKES** are 15/32" high, bright zinc-plated with rounded corners to reduce scratches.

Order **3x1/2NP** screws separately.

